







Panic Devices

TOUCH-BAR REVERSIBLE – MODULAR

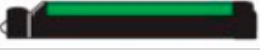
Steel latch bolts

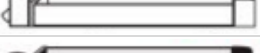
Black painted steel covers

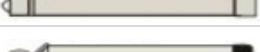
Vertical Rods and Outside Trims same as "400"

| Color Code | Description | Color |
|------------|--|-------------------------------|
| NR |  | Black/Red RAL 9005/3020 |
| NV |  | Black/Green RAL 9005/6029 |
| NN |  | Black/Black RAL 9005/9005 |
| GG |  | Gray/Gray RAL 7040/7040 |
| BB |  | White/White RAL 9010/9010 |
| NS |  | Black/Silver RAL 9005/All. |
| AA |  | Steel finish special painting |
| XX |  | Satin Chrome |

| Reference | Length | Description |
|-----------|--------|------------------|
| 601/1/ | 840mm | 1 locking point |
| 601/2/ | 1170mm | |
| 601/3/ | 1300mm | |
| 602/1/ | 840mm | 2 locking points |
| 602/2/ | 1170mm | |
| 602/3/ | 1300mm | |
| 603/1 | 840mm | 3 locking points |
| 603/2 | 1170mm | |
| 603/3 | 1300mm | |



P
A
N
I
C

D
E
V
I
C
E

Panic Devices

| Reference | Length | Description |
|-----------|--------|---|
| 603/1/AA | 840mm | 3 locking point Steel finish special painting |
| 603/2/AA | 1170mm | |
| 603/3/AA | 1300mm | |

| Reference | Length | Description |
|-----------|--------|---------------------------------|
| 603/2/XX | 1170mm | 3 locking point Satin Chrome |
| 603/3/XX | 1300mm | |

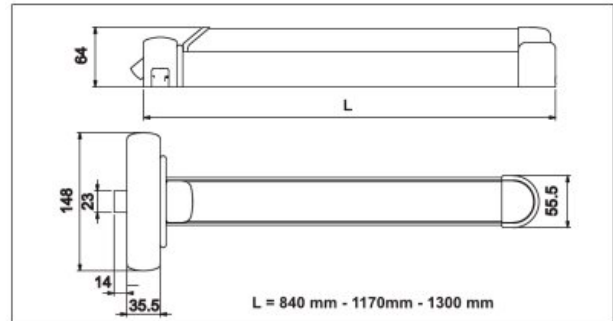

P
A
N
I
C

D
E
V
I
C
E